



DATA SHEET

# TITANTURBO™

LED LIGHT ENGINES

INTRODUCTION: TITANTURBO™ LED LIGHT ENGINES .....	3
CHARACTERISTICS	
FLUX - LUMENS, JUNCTION TEMPERATURE, $T_j=25^{\circ}\text{C}$	
WARM WHITE, DAYLIGHT WHITE, AND TRUCOLOR.....	4
OPTICAL - WARM WHITE, DAYLIGHT WHITE, AND TRUCOLOR .....	4
TYPICAL ILLUMINANCE - WARM WHITE, DAYLIGHT WHITE, AND TRUCOLOR .....	4
ELECTRICAL PERFORMANCE, JUNCTION TEMPERATURE, $T_j=25^{\circ}\text{C}$	
WARM WHITE, DAYLIGHT WHITE, AND TRUCOLOR.....	4
MINIMUM TYPICAL, AND ABSOLUTE MAXIMUM	
RATINGS - WARM WHITE, DAYLIGHT WHITE, AND TRUCOLOR.....	4
SPECTRAL DISTRIBUTION	
WARM WHITE, DAYLIGHT WHITE, AND TRUCOLOR.....	5
TYPICAL RELATIVE FORWARD CURRENT VS. FORWARD VOLTAGE	
WARM WHITE, DAYLIGHT WHITE, AND TRUCOLOR.....	6
RELATIVE LUMINOUS FLUX VS. JUNCTION TEMPERATURE	
WARM WHITE, DAYLIGHT WHITE, AND TRUCOLOR.....	7
FLUX VS. CURRENT	
WARM WHITE, DAYLIGHT WHITE, AND TRUCOLOR.....	8
EFFICACY VS. CURRENT	
WARM WHITE, DAYLIGHT WHITE, AND TRUCOLOR.....	9
BIN STRUCTURE	
WARM WHITE, DAYLIGHT WHITE.....	10
PROJECTED LUMEN MAINTENANCE	
WARM WHITE, DAYLIGHT WHITE, AND TRUCOLOR.....	11
RELATIVE LUMINOUS INTENSITY AND WARM WHITE, DAYLIGHT WHITE .....	11
MECHANICAL DIMENSIONS	
WARM WHITE, DAYLIGHT WHITE, AND TRUCOLOR.....	12
WIRING HARNESS .....	12
PACKAGING TRAYS .....	12
PATENTS AND CONNECTIONS.....	13
ASSEMBLY AND PACKAGING .....	13
ROHS AND WARRANTY .....	14

# TABLE OF CONTENTS

# TITANTURBO™ SERIES LED LIGHT ENGINES

Lamina LED light engines are manufactured by combining high brightness LEDs from industry-leading LED manufacturers with our own proprietary thermal packaging technology. This technology is a performance breakthrough for LED packaging, a key factor in determining LED life and reliability. This unmatched thermal performance allows Lamina to densely cluster multiple LEDs to achieve exceptionally high luminous intensity in very small footprints.

The Lamina TitanTurbo is available in 3050K Warm White, 4700K Daylight White, and 3050K TruColor. The TitanTurbo 3050K Warm White delivers 1000+ lumens. Enhanced red and orange color spectrum make this product ideal for incandescent and halogen replacements.

TitanTurbo LED light engines are configured with an array of cavities each populated with multiple LED to deliver the maximum in usable light. TitanTurbo makes possible applications which, until now, could only be accomplished with traditional lighting sources.

## Features:

- Integral EZ-Connector eliminates the need for soldering
- Lamina narrow, medium and wide beam optics available
- Isolated metal base - makes wiring in series or parallel possible on a common heat sink
- Integrated ESD protection - 4,000V HBM
- Superior thermal performance for improved reliability
- Long-life and high lumen maintenance

The unsurpassed technical benefits found in the TitanTurbo result in unparalleled ease of design and integration. Additionally, Lamina provides unmatched product integration support. Our experienced Sales Application Engineers, knowledgeable in LED design integration, optics, heat sinks, and electronics are just a phone call away. To request a sample or to speak to an Application Engineer, call us at 800-808-5822 or +1 609-265-1401.

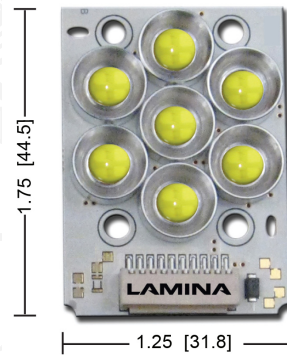

## APPLICATIONS



INTRODUCTION

# CHARACTERISTICS

## Flux Characteristics - Lumens Junction Temperature, $T_j=25^\circ\text{C}$

Product Number	Color	Drive Current (mA)	TYP / MIN (lm)
NT-54D1-0486	Warm White	5000	1058 / 846
NT-54D0-0487	Daylight White	5000	1853 / 1482
NT-54D2-0509	TruColor	2000	1290 / 1100

Table 1.

## Optical Characteristics

Product Number	Color	Color Temp. (K)	Total Incl. Angle	<sup>(1)</sup> View Angle	TYP / MIN CRI
NT-54D1-0486	Warm White	3050	150°	70°	78 / 70
NT-54D0-0487	Daylight White	4700	150°	70°	68 / 60
NT-54D2-0509	TruColor	3050	150°	70°	85 / 80

Table 2.

Note: 1.  $2\theta$ , 1/2, Total off-axis angle from source center line where the intensity is 1/2 of the peak value.

## Typical Illuminance Characteristics

Part Number	Color	Drive Current (mA)	cbcp	Illuminance (Lux) Distance from Source (m)				Illuminance (fc) Distance from Source (ft)			
				1	2	5	10	3.3	6.6	16.4	32.8
NT-54D1-0486	Warm White	5000	798	798.3	200	32	8.0	74	19	3	0.7
NT-54D0-0487	Daylight White	5000	1418	1418	355	57	14.2	132	33	5	1.3
NT-54D2-0509	TruColor	2000	996	996	249	40	10.0	93	23	4	0.9
		2500	1258	1258	315	50	12.6	117	29	5	1.2
		3000	1456	1456	364	58	14.6	135	34	5	1.4

Table 3.

## Driving Lamina Light Engines

Lamina TitanTurboLED light engines are designed to operate under current controlled conditions, either constant current, PWM or other current control methods. The TitanTurbo is designed to operate using commercially available driver sources from many electronic power supply companies. Lamina's Application Engineering team can assist with the proper selection of drivers and your own drive current design.

Connecting power to high brightness LEDs in the past has been challenging. Lamina has developed EZ-Connect boards and wire harnesses to make assembly fast and reliable.

## Electrical Performance Characteristics Junction Temperature, $T_j=25^\circ\text{C}$

Product	Color	*Current (mA)	Forward Voltage (VDC)		Typical Power (W)	Typical Temperature Coefficient of Forward Voltage (mV/°C)	Typical Thermal Resistance Junction to Case (°C/W)
			Typ.	Max.			
NT-54D1-0486	Warm White	5000	11.3	14.1	56.5	TBD	.60
NT-54D0-0487	Daylight White	5000	11.3	14.1	56.5	TBD	.60
NT-54D2-0509	TruColor	2000	12.0	15.0	24	TBD	.60

Table 4.

\*Total, all 3 channels combined.

## Minimum, Typical, and Absolute Maximum Ratings, Warm White (NT-54D1-0486) and Daylight White (NT-54D0-0487), and TruColor (NT-54D2-0509)

	Symbol	Min.	Typ.	Max.	Unit
Thermal Resistance <sup>(1)</sup>	$T_R$	-	0.9	1.2	°C/W
Insulation Resistance <sup>(2)</sup>	-	1.0	-	-	MΩ
Electrical Isolation <sup>(3)</sup>	-	100	-	-	V
Reverse Current	-	-	-	50	mA
Reverse Voltage	-	-	-	5	V
LED Junction Temperature <sup>(4)</sup>	$T_j$	-	-	+115	°C
Storage Temperature	-	-40	-	+100	°C
Assembly Temperature	-	-	-	+210	°C
ESD Sensitivity	HBM	-	-	4000	V
Current (D1, D0)	mA	-	5000	6500	mA DC
Current (D2)	mA	-	2000	4000	mA DC

Table 5.

Notes: 1. Thermal resistance including thermal grease (Wakefield P/N 120), as measured from LED junction to heat sink. 2. Insulation resistance between any terminal and base. 3. Electrical isolation voltage between any terminal and base. 4. Lower junction temperatures improve lumen maintenance.

# SPECTRAL DISTRIBUTION @5000MA, 25°C HEAT SINK

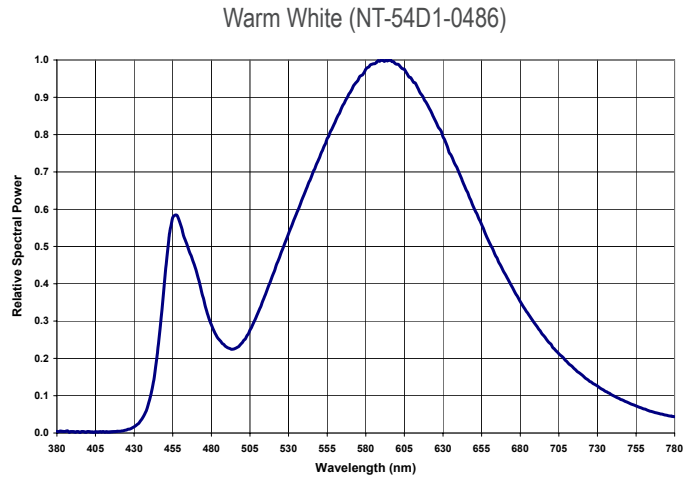

Figure 1a.

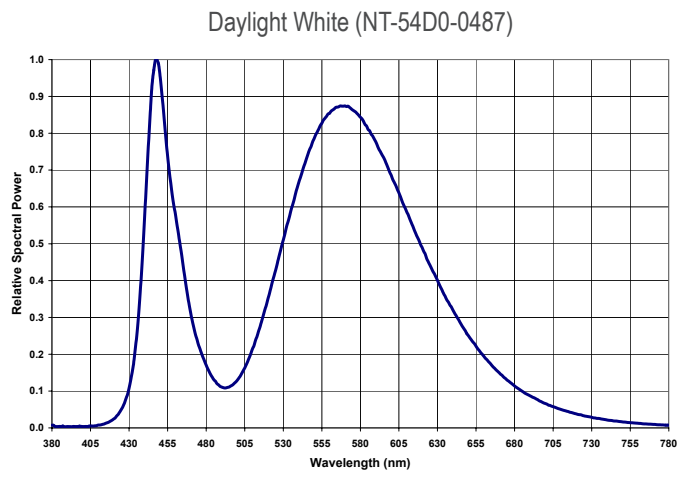

Figure 1b.

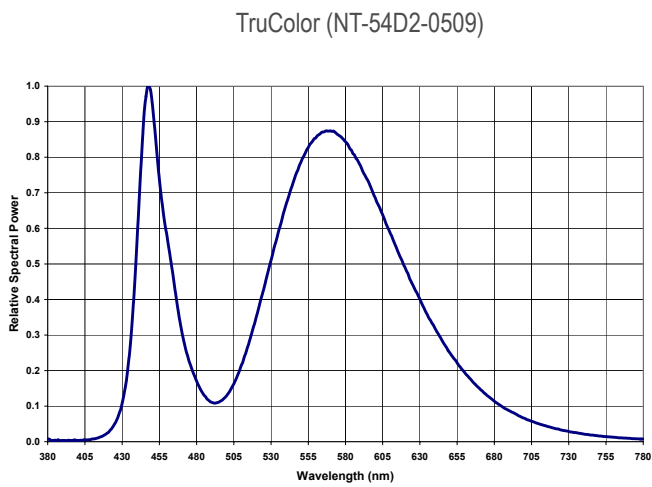

Figure 1c.

# TYPICAL RELATIVE FORWARD CURRENT VS. FORWARD VOLTAGE

Warm White (NT-54D1-0486)

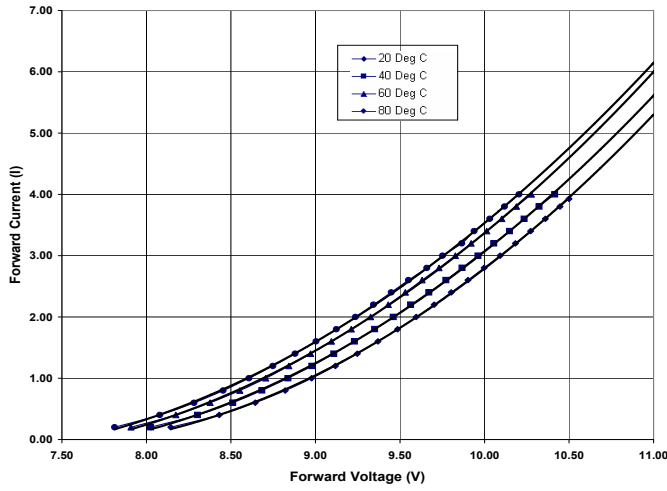

Figure 2a.

Daylight White (NT-54D0-0487)

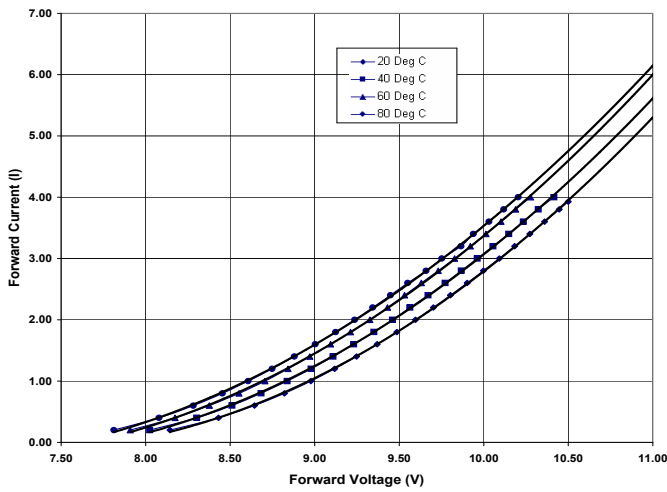

Figure 2b.

TruColor (NT-54D2-0509)

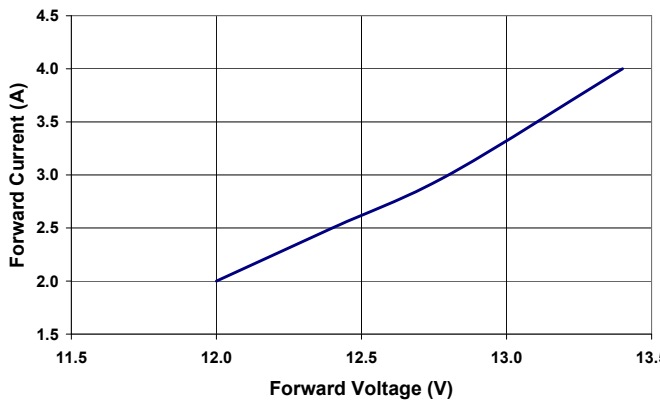
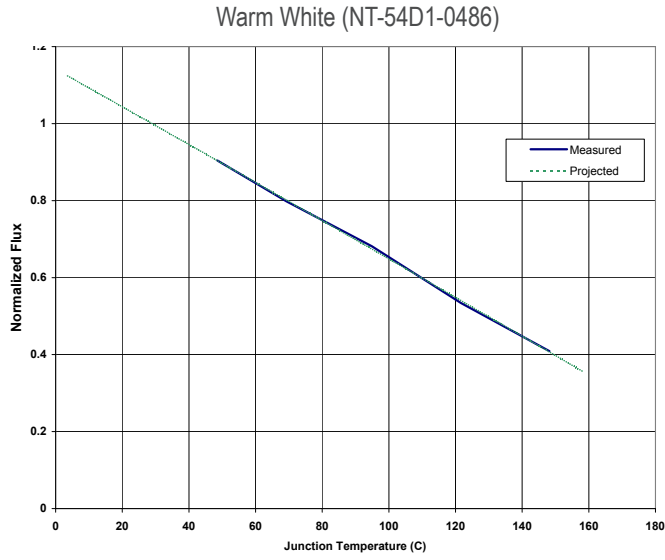

Figure 2c.

# RELATIVE LUMINOUS FLUX VS. JUNCTION TEMPERATURE



---- Projected  
 — Measured

Figure 3a.

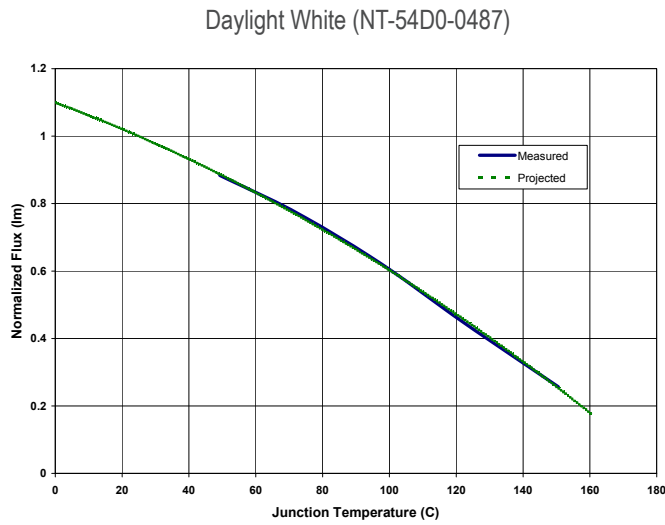

---- Projected  
 — Measured

Figure 3b.

TruColor (NT-54D2-0509)

Available 2nd Quarter 2008

---- Projected  
 — Measured

Figure 3c.

# FLUX VS. CURRENT

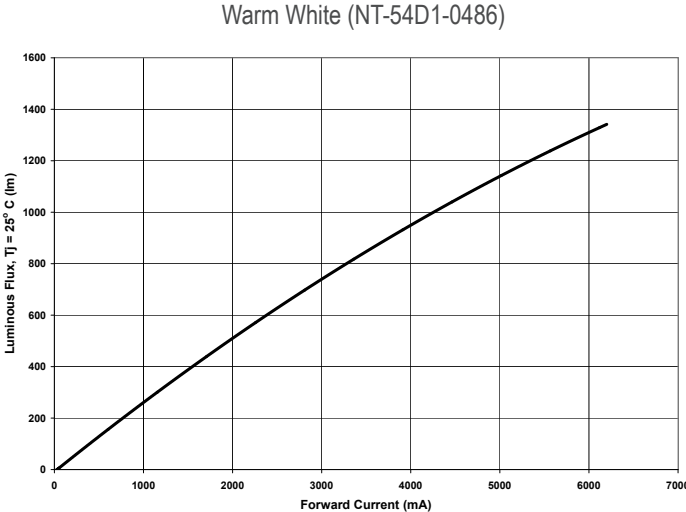

Figure 4a.

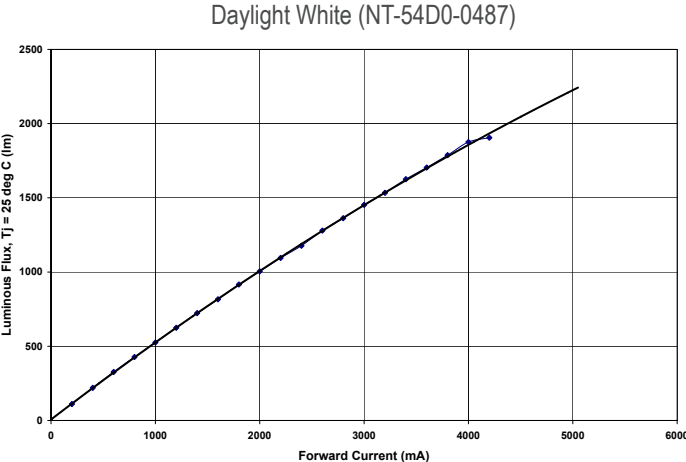

Figure 4b.

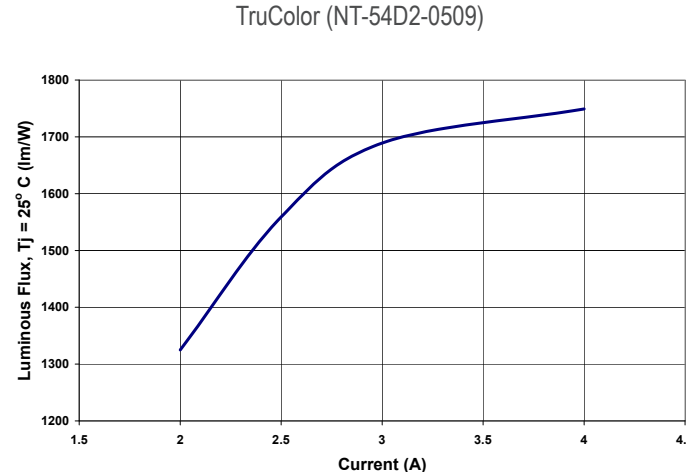

Figure 4c.





# EFFICACY VS. CURRENT

## Warm White (NT-54D1-0486)

Figure 5a.

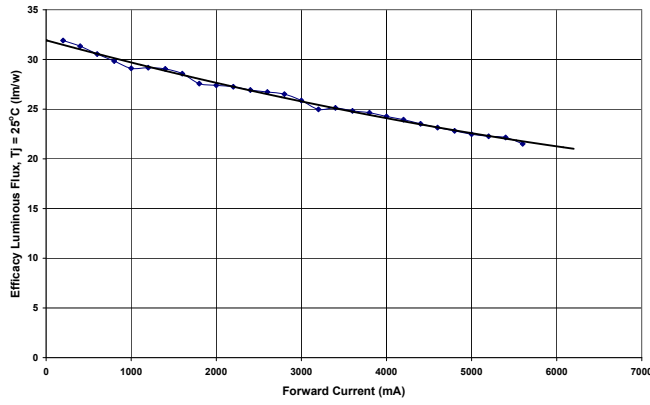

## Daylight White (NT-54D0-0487)

Figure 5b.

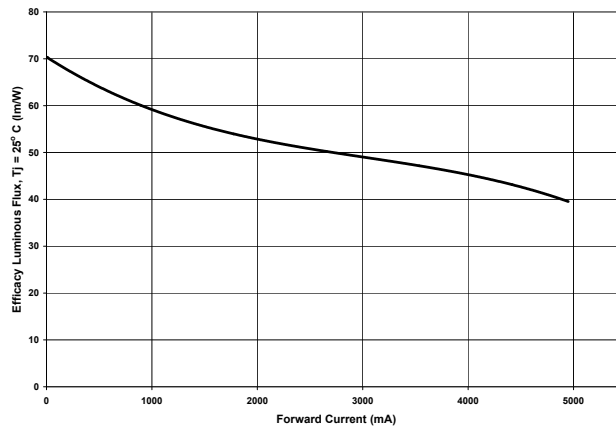

## TruColor (NT-54D2-0509)

### Efficacy vs. Current TruColor NT-54D2-0509

Figure 5c.

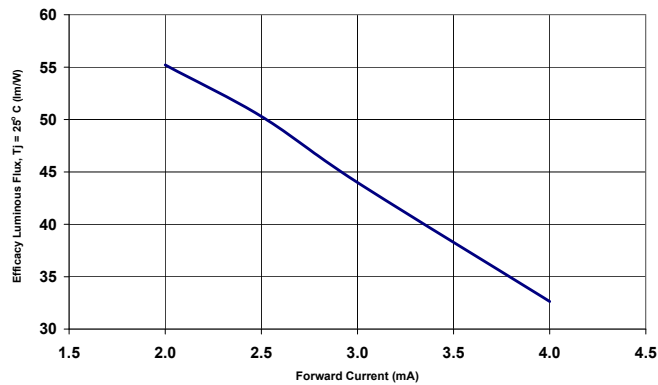

# BIN STRUCTURE

## Warm White (NT-54D1-0486) & TruColor (NT-54D2-0509)

Figure 6a. CIE Reference 1931, 2°

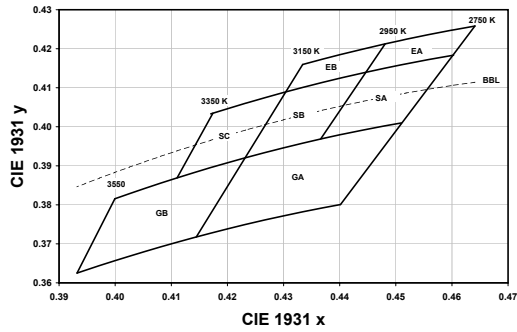

Bin Code	X	Y	Typical CCT (°K)
EB	0.4481	0.4212	3050
	0.4448	0.4140	
	0.4305	0.4089	
	0.4334	0.4159	
EA	0.4641	0.4258	2850
	0.4603	0.4183	
	0.4448	0.4140	
	0.4481	0.4212	
SC	0.4305	0.4089	3250
	0.4232	0.3920	
	0.4110	0.3869	
	0.4174	0.4034	
SB	0.4448	0.4140	3050
	0.4366	0.3968	
	0.4232	0.3920	
	0.4305	0.4089	
SA	0.4603	0.4183	2850
	0.4510	0.4009	
	0.4366	0.3968	
	0.4448	0.4140	
GB	0.4232	0.3920	3350
	0.4144	0.3717	
	0.3932	0.3625	
	0.3999	0.3815	
GA	0.4510	0.4009	2950
	0.4401	0.3800	
	0.4144	0.3717	
	0.4232	0.3920	

Table 6a. Note: Typical relative Warm White Bin NT-54D1-0486.

## Daylight White (NT-54D0-0487)

Figure 6b. CIE Reference 1931, 2°

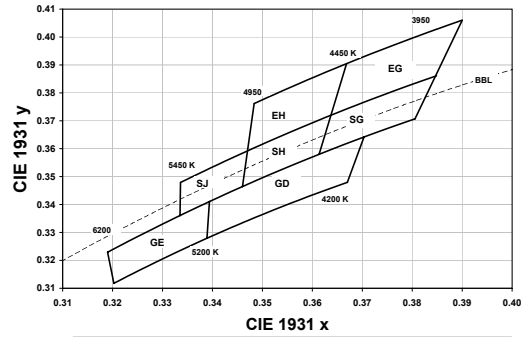

Bin Code	X	Y	Typical CCT (°K)
EH	0.3668	0.3904	4700
	0.3637	0.3719	
	0.3469	0.3591	
	0.3483	0.3761	
EG	0.3900	0.4060	4200
	0.3848	0.3861	
	0.3637	0.3719	
	0.3668	0.3904	
SJ	0.3469	0.3591	5200
	0.3460	0.3464	
	0.3335	0.3360	
	0.3336	0.3479	
SH	0.3637	0.3719	4700
	0.3613	0.3580	
	0.3460	0.3464	
	0.3469	0.3591	
SG	0.3848	0.3861	4200
	0.3805	0.3706	
	0.3613	0.3580	
	0.3637	0.3719	
GE	0.3394	0.3410	5700
	0.3389	0.3279	
	0.3202	0.3117	
	0.3190	0.3229	
GD	0.3703	0.3641	4700
	0.3670	0.3479	
	0.3389	0.3279	
	0.3394	0.3410	

Figure 6b. Note: Typical relative Daylight White Bin NT-54D0-0487.

# PROJECTED LUMEN MAINTENANCE

Lifetime for solid-state devices (LEDs) is typically defined in terms of lumen maintenance - the percentage of initial light output remaining after a specified period of time.

The Warm White (NT-54D1-0486), Daylight White (NT-54D0-0487), and True Color (NT-54D2-0509) will deliver 70% lumen maintenance at 50,000 hours of operation at a forward current of 5000mA. This projection is based on constant current operation with junction temperature maintained at or below 120°C.

This performance is based on independent test data. Lamina's historical data from tests run on similar material systems and internal reliability testing. Observation of design limits included in this data sheet is required in order to achieve this project lumen maintenance.

Warm White (NT-54D1-0486), Daylight White (NT-54D0-0487) and TruColor (NT-54D2-0509)

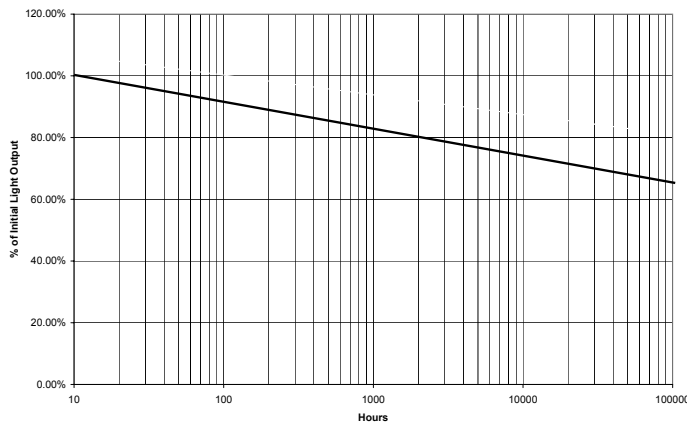

Figure 6.

# RELATIVE LUMINOUS INTENSITY

Warm White (NT-54D1-0486), Daylight White (NT-54D0-0487)

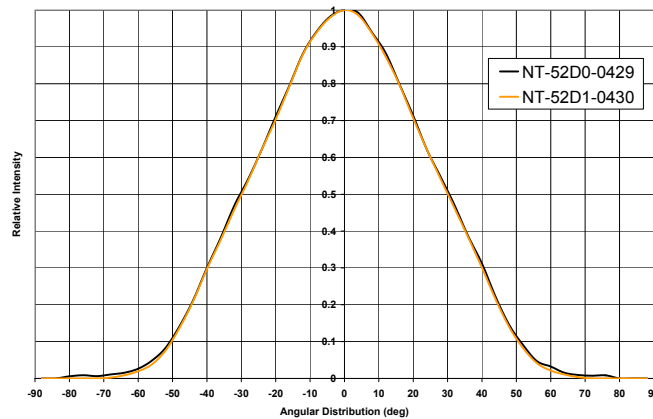

Figure 7.

Typical Beam Pattern - Lamina's TitanTurbo LED light engines project a 108° - 132° (2θ, 1/2, 50% of peak value) Lambertian radiation pattern. Narrower beam distributions can be produced by use of selected popular LED optics. Please contact Lamina Application Engineering for support with your optical needs.

# MECHANICAL DIMENSIONS

Warm White (NT-52D1-0486) and  
Daylight White (NT-52D0-0429) (Polar)

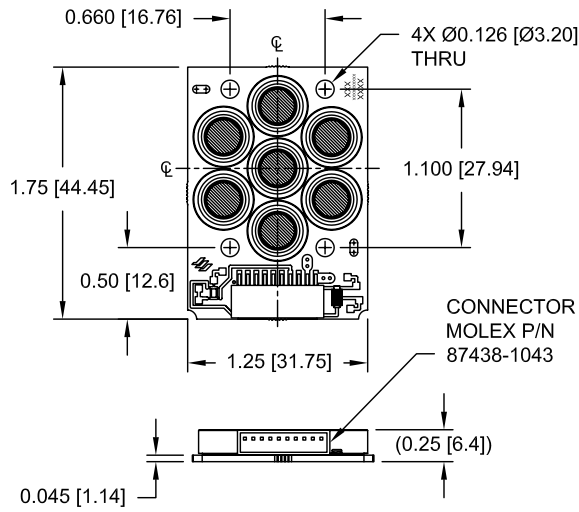

Figure 8.  
All dimensions are for reference only  
Do not handle device by the lens.  
Care must be taken to avoid damage to the lens. Drawing not to scale.

Units: Inches [millimeters]

# WIRING HARNESS

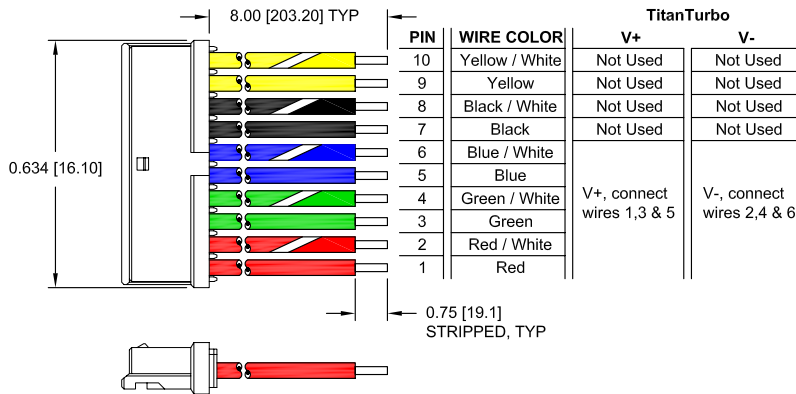

Figure 9.

# PACKAGING TRAYS

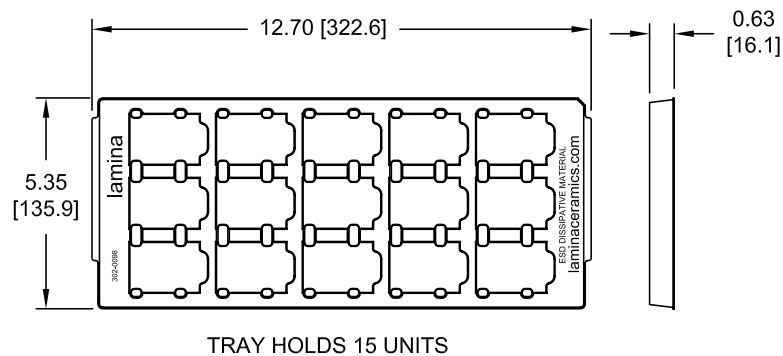

Figure 10.

# PATENTS AND CONNECTIONS

## PATENTS

Lamina's light engines may be covered by pending patents and/or one or more of the following U.S. and/or International patents 5876536, 6709749 B, 595880, 6017642, 5565262, 5681444, 5653834, 5581876, 5847935, 5514451, 5747931, 5925203, 5725808, 5929510, 5858145, 5866240, 5953203, 6055151, 614076, 6011330, 6399230, 6914501, 6168490, 6191934, 614075, 6160469, 6300267, 6471805, 6518502, 6739047, 6720859, 6759940, 6518502, 6670856 B1, 6720859, 6713862 B2, WO 00/47399, WO 00/26152, WO 98/19339, 5082804, ZL99808762.9, 69623930, 69628549, 69629572, 805785, 69628549, 843621, 932500, 805785, 812258, 843621, 932500, 805785, 812258, 843621, 932500, 805785, 812258, 843621, 932500, 3327556, 3267299, 3226281, 3405545, 320630, 295695, 284068, 546471, 805785, 812258, 843621, 6455930, 6759940, 6713862, 7095053, 7098483.

## ELECTRICAL CONNECTIONS

LED light engines are available with or without Lamina's EZ-Connect board. EZ-Connect adapter boards have AMP connectors for solderless connections to Lamina's wiring harness.

As with many electrical devices, non-acid RMA type solder flux should be used to prepare the solder pads before application of solder. Ensure proper strain relief of wires attached to the light engine to prevent damage to the light engines solder pads. For more information refer to Lamina's connection application note AN-05 which can be found on the website at [www.laminalighting.com](http://www.laminalighting.com).

Functional test: Parts may be tested using a constant current source set at 25% of Drive Current for no more than two seconds without heat sink.

1. Optical and electrical specifications are given for the specified drive @ 25°C junction temperature.
2. When using constant current LED drivers with high compliance voltage (Advance, LEDworks, etc. or a custom driver) the output of the supply must be connected to the part before power is applied to the input of the supply.

# ASSEMBLY AND PACKAGING

## RECEIVING PARTS AND PACKAGING TRAYS

Your parts will arrive in either custom fitted trays or on easy to use tape and reel packaging. This packaging was designed to provide the necessary protection during shipment and to take up the least amount of space in your storage area.

### Notes

1. This product uses silicone materials for superior optical performance. Do not expose the part to fluids that may react with silicone compounds. See Dow Chemical Form 45-0113D-01, Silicone Fluid Resistance Guide.
2. Ray trace models are available upon request.
3. Lamina may make process or materials changes affecting the performance or other characteristics of our products. These products supplied after such changes will continue to meet published specifications, but may not be identical to product supplied as samples or under prior orders.
4. All specifications are based on mounting the LED array to a heat sink using the specified hardware and thermal grease Wakefield P/N 120. The heat sink must meet the specified flatness requirement. Mounting using screws and thermal tape may damage the device.

# RoHS AND WARRANTY

## LAMINA LIGHT ENGINES COMPLY WITH RoHS RESTRICTIONS

Lamina Light Engines are compliant with all of the criteria proposed by the European RoHS Directive 2002/95/EC for hazardous material content in electronic and electrical equipment as listed in Annex 1A and 1B of the WEEE Directive.

In addition to containing no mercury, Lamina's LED Light Engines have the following environmental advantages over traditional light sources:

- High energy efficiency
- Long lifetime
- Fully dimmable
- Very low IR and UV radiation

For attachment of electrical connections Lamina recommends the use of lead-free solder.

## WARRANTY STATEMENT

Lamina Lighting Incorporated (Seller) extends warranty on goods produced by the Seller for one (1) year from original date of shipment, that the goods sold hereunder are new and free from substantive defects in workmanship and materials. This warranty extends only to the Buyer and not to indirect purchasers or users. Seller's liability under the foregoing warranty is limited to replacement of goods or repair of defects or refund of the purchase price at the Seller's sole option. The above warranty does not apply to defects resulting from the improper or inadequate maintenance, unauthorized modification, improper use or operation outside of Seller's specifications for the product, abuse, neglect or accident. THE ABOVE WARRANTY IS EXCLUSIVE AND NO OTHER WARRANTY, WHETHER WRITTEN OR ORAL, IS EXPRESSED OR IMPLIED. LAMINA LIGHTING INCORPORATED SPECIFICALLY DISCLAIMS THE IMPLIED WARRANTIES OF MERCHANTABILITY AND FITNESS FOR A PARTICULAR PURPOSE. - LAMINA LIGHTING INCORPORATED - June 21, 2006.



©2008 Lamina Lighting Incorporated. Lamina is a registered trademark and the Lamina logo, Titan, TitanTurbo, S6L and TruColor EZ-Connect are trademarks of Lamina Lighting Incorporated. All other trademarks mentioned are the property of their respective owners.